

RECOMMENDED PCB LAYOUT  
TOLERANCE: ±0.05  
TOP VIEW

### MATERIALS

- HOUSING : LCP, BLACK.
- TERMINAL : COPPER ALLOY (T=0.20mm)  
PLATING: SELECTIVE GOLD ON CONTACT AREA,  
TIN PLATED ON SOLDER TAILS,  
UNDER NICKEL PLATED OVERALL.
- SHELL : STAINLESS STEEL (T=0.30mm)  
PLATING: NICKEL PLATED OVERALL.
- COVER: LCP, BLACK.
- MYLAR: POLYESTER FILM.

### SPECIFICATION

- CURRENT RATING : 0.5A MAX
- CONTACT RESISTANCE : 30mΩ MAX.
- DIELECTRIC WITHSTANDING VOLTAGE :  
500V AC R.M.S. FOR ONE MINUTE.
- INSULATION RESISTANCE : 100MΩ MIN AT 500V DC.
- OPERATING TEMPERATURE : -25°C TO +85°C.
- DURABILITY : 10000 CYCLES.
- MATING FORCE : 4.5Kgf MAX.
- UNMATING FORCE : 1.0Kgf~4.0Kgf.



深圳市华宇创精密电子有限公司

TOLERANCE: X.X ±0.30 X.XX ±0.25 X.XXX ±0.15 X' ±2' X.X' ±0.5'	DRAWN BY : 陈一鸣	DATE : 2014-02-23	PART NAME: MINI DP SMT式母座(中心高3.8)
	CHECKED BY: 马跃	DATE : 2014-02-23	PART NO. : HVC29-MDP20-038
UNIT: mm [inch] SCALE:1:1 SIZE: A4	APPROVED BY: 邱敏	DATE : 2014-02-23	MOLD NO. : /
			DRAW NO. : HVC-2603301420
			SHEET NO. : 1 OF 1

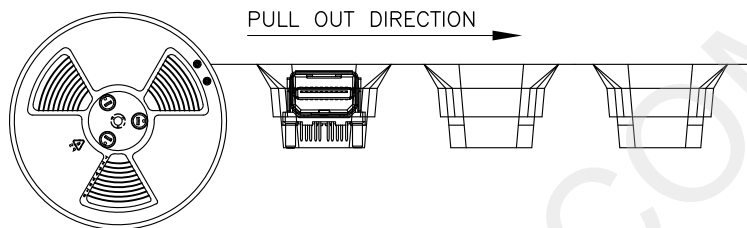
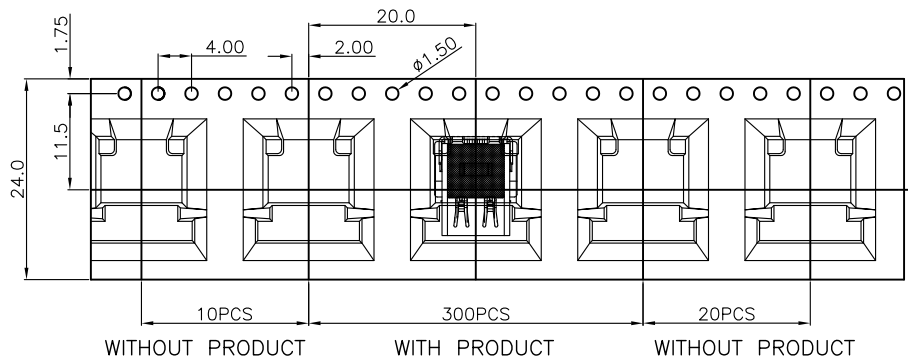

**PACKAGE**

1. SIZE :  
 REEL : DIA.=330mm  
 CORTON : 350x350x340mm (LxWxH)
2. QUANTITY :  
 300 PCS/REEL  
 11 REEL/CARTON = 3300PCS

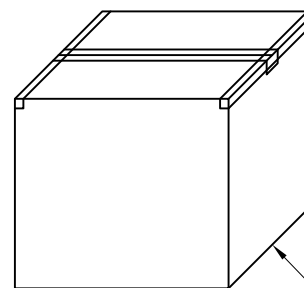
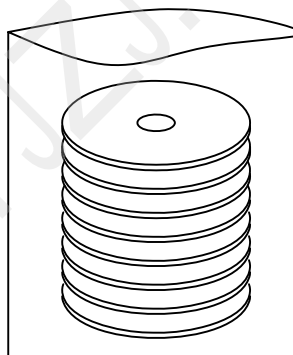
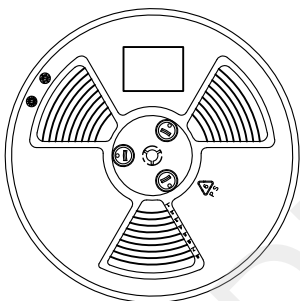
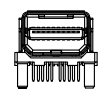

 <b>深圳市华宇创精密电子有限公司</b>			
TOLERANCE: X.X ±0.30 X.XX ±0.25 X.XXX ±0.15 X.' ±2' X.X' ±0.5'	DRAWN BY : 陈一鸣	DATE : 2014-02-23	PART NAME: 包装图
	CHECKED BY: 马跃	DATE : 2014-02-23	PART NO. MOLD NO.
UNIT: mm [inch] SCALE:1:1 SIZE: A4	APPROVED BY: 邱敏	DATE : 2014-02-23	DRAW NO: SHEET NO. 1 OF 1